

**Engineering progress
Enhancing lives**

Modern design made easy

RAUVISIO surface solutions and custom cabinet doors with zero-joint perfection.

Visit na.rehau.com/cabinetdoors



With zero-joint perfection and over one hundred finishes, REHAU takes the stress out of modern cabinet design. We deliver so you can do what you do best - **satisfy your customers.**

REHAU offers globally curated, meticulously chosen collection of surfaces and cabinet doors for modern spaces. Our custom, fully fabricated doors make it easier, regardless of volume, to take advantage of the growing demand for modern design.

Contents

| | | | | | |
|----|---|--|----|---|------------------------|
| | High-gloss | | | | Metallic |
| 6 | RAUVISIO brilliant™ Mirror high-gloss acrylic surface | | 44 | RAUVISIO ferro™ Metallic PET surface | |
| | Matte | | | | Tambour |
| 12 | RAUVISIO noir™ Monotonic matte surface | | 48 | Metallic-Line™ Metal tambour doors | |
| 16 | RAUVISIO noir™ compact Monotonic matte phenolic surface | | 52 | Vetro-Line™ Glass tambour doors | |
| 18 | RAUVISIO matte™ Super-matte PET surface | | | | Handles |
| | Crystal | | 56 | Integrated handles Modern aluminum profiles | |
| 24 | RAUVISIO crystal™ Back-painted acrylic surface | | | | Shelves |
| 28 | RAUVISIO crystal slim™ Back-painted acrylic wall panel surface | | 58 | REHAU Floating Shelves Structural storage system | |
| | Natural | | | | Getting Started |
| 34 | RAUVISIO terra™ Soft, textured HPL surface | | 60 | Create your online account | |
| 38 | RAUVISIO wave™ Structured laminate surface | | | | |

A photograph of a birthday celebration. In the foreground, a woman with dark hair, wearing a light pink off-the-shoulder top, is smiling. To her left, a birthday cake with lit candles is visible. In the background, a kitchen counter holds several bottles (beer, wine, and a vase with flowers), string lights, and a plate of appetizers. The scene is warmly lit, suggesting an indoor evening gathering.

**Engineering progress
Enhancing lives**

Add depth with high-gloss

Give your clients something to reflect on for years. RAUVISIO surfaces provide the perfect solution for any type of high-gloss project.





RAUVISIO brilliant



20+ years of UV stability allow your white to stay white



Mirror-like reflective quality to view life perfectly at any angle



Double-sided high-gloss for a true monolithic panel

RAUVISIO brilliant™ offers the highest quality in high-gloss. Our components feature double-sided, high-gloss acrylic surfaces laminated onto super-refined MDF in a PUR clean room environment to ensure a mirror-like reflective quality.



RAUVISIO brilliant is the next generation in high-gloss surfaces, surpassing high-quality lacquered boards with a brilliant depth effect.



Unlike competitive surfaces using a clear top layer, we color match our PMMA top layer to the acrylic laminate, adding color depth and **20+ years of UV resistance.**





Shine
bright with
vibrant
color

Color Selection

| | | | |
|---|---|--|---|
|  |  |  |  |
| Bianco 5000B | Meringa 5026B | Magnolia 5335B | Notte* 1680L |
|  |  |  |  |
| Moro 5112B | Prugna 5642B | Cappuccino 1917L | Cemento 1919L |
|  |  |  |  |
| Cubanite* 5338B | Gabbiano* 6339B | Bigio* 6340B | Grafite 2100L |
|  |  | | |
| Roccia 2101L | Titanio 2283L | | |

* Please note these colors have directionality

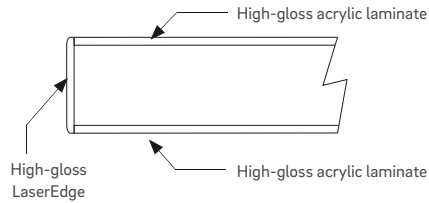
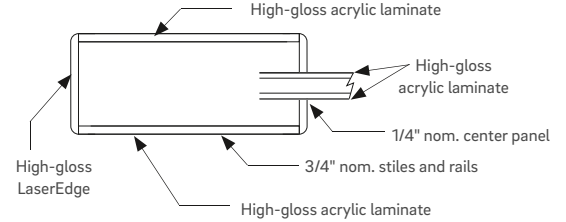
Slab profile**Shaker profile****Top:** Slab door and drawer**Bottom:** Shaker door**Profile Specifications**

| | |
|-------------------------|--|
| Appearance | High-gloss |
| Door style | Slab and shaker |
| Design style | Modern, contemporary |
| Construction | PUR laminated face and back, REHAU LaserEdge |
| Shaker stiles and rails | 3 in (76.2 mm), custom widths also possible |
| Face material | High-gloss acrylic, multiple colors |
| Back material | High-gloss acrylic, matching color |
| Edgeband | REHAU LaserEdge, matching color |
| Core | Super-refined MDF |
| Board thickness | 3/4 in (19.5 mm) |

Size Parameters

| | |
|----------------|--------------------------------|
| Minimum | 3 x 5 in (76.2 x 127 mm) |
| Maximum | 50 x 109 in (1270 x 2768.6 mm) |
| Minimum shaker | 8 7/8 x 10 in (225.4 x 254 mm) |

Edgebanding Profile

| | |
|---------------------------|--|
| Top edge | 1.0 mm radius |
| Bottom edge | 1.0 mm radius |
| Edgeband finish, standard | Mirror gloss, color matched |
| Edgeband finish, optional | V-edge two-toned metallic, color matched (select colors) |

Accessory Products

| | |
|--------------------------|---------------------------------------|
| 1/4 in. thick components | Cut-to-size with raw edges |
| Integrated handle | 1 17/64 and 5/64 in (32 and 2 mm) |
| Floating shelves | 22 to 96 in (558.8 to 2438.4 mm) wide |



RAUVISIO brilliant is offered as individual matching components (laminate, pressed board and edgeband) or as finished, cut-to-size components with REHAU LaserEdge applied, making high-gloss available to any shop without investment in machinery.



What is REHAU LaserEdge?

REHAU LaserEdge™ is an adhesive-free edgeband with a co-extruded polymer functional layer replacing the traditional glue used to apply edgeband. The technology allows for a superior and seamless joint between the edgeband and the board.

Board Specifications

RAUVISIO brilliant is flat-laminated to a high-quality, super-refined, engineered MDF core that is PEFC, CARB2, TSCA Title VI certified which provides a stable, consistent substrate and virtually eliminates warping.

Edgeband Specifications

All components are edgebanded with REHAU LaserEdge, which provides an extremely heat and moisture resistant seamless joint rivaling solid surfaces and exceeds high-end lacquer finishes.

Cleaning and Care

Clean with a damp microfiber cloth and with a mild soap if needed. Do not dry-wipe the acrylic finish. Avoid abrasive cleaners, solvent-based cleaners and harsh chemicals. Do not use paper towels, brushes or scouring pads. REHAU is not responsible for any damage done by abrasive cleaning products or procedures.

Protective Coat

A protective peel coat is applied to the top of the high-gloss surface, as well as to the edgebanded sides. Do not expose peel coat to direct sunlight before removal. Remove promptly after installing cabinet but prior to mounting decorative hardware. To remove peel coat, use rubber fingertips or our peel coat removal tool.

Experience the super-soft look and feel of matte

Make your client a trend-setter when you specify matte surfaces in their next project.





RAUVISIO noir



Double-sided matte for a true monolithic panel



Extremely durable with independent healing



Anti-fingerprint so matte black can stay clean

RAUVISIO matte



Durable and scratch resistant



Features a smooth, soft touch for comfort

Forged with the finest materials to create a monotonic matte surface, **RAUVISIO noir**[™] builds a refined foundation for even the most exuberant designs.



**Seamless,
tactile
matte**

without fingerprints













2020 Product Innovations
award winner
Buildings and interiors+sources

What is monotonic matte?

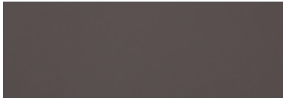
A monotonic matte surface has the ability to retain all of its elemental properties while delivering unwavering resilience, reliability and richly uninhibited elegance in a variety of different scenarios giving you the quality you deserve with the versatility you desire.

The deeply light-absorbent surface withstands scratches and fingerprints while providing the deepest, touchable matte.

Color Selection

| | | | |
|---|---|--|---|
|  |  |  |  |
| High Low 154707 | Casa Blanca 154705 | Capital Starlit 154706 | Maltese Mist 154704 |
|  |  |  |  |
| Gaslit Alley 154712 | Trench Coat 154711 | Silver Lake 154709 | Smoke Stack 154710 |
|  |  |  |  |
| After Dark 154708 | Midnight Dash 154713 | Olive Detour 154715 | Boxcar Blonde 154714 |

Our components feature double-sided monotonic matte with matching REHAU LaserEdge elegant matte edgeband. The monotonic matte HPL is laminated onto a MDF core to ensure the highest quality finish.

Slab profile

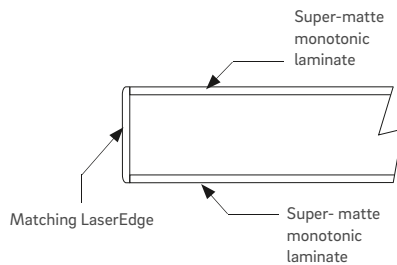

Shaker profile

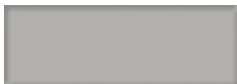
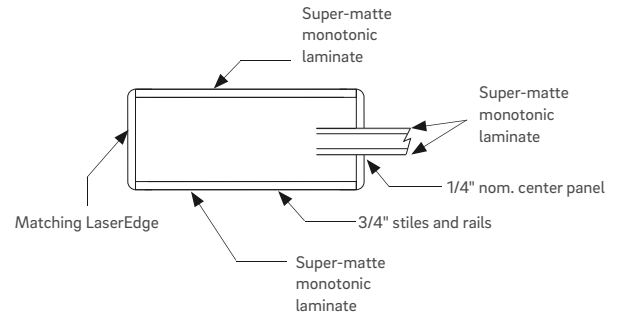

Top: Slab door and drawer
Bottom: Shaker door

Profile Specifications

| | |
|-------------------------|---|
| Appearance | Super-matte |
| Door style | Slab and shaker |
| Design style | Modern, contemporary |
| Construction | PVA laminated face and back, REHAU LaserEdge |
| Shaker stiles and rails | 3 in (76.2 mm), custom widths also possible |
| Face material | Super-matte monotonic laminate, multiple colors |
| Back material | Super-matte monotonic laminate, matching colors |
| Edgeband | REHAU LaserEdge, matching color |
| Core | MDF |
| Board thickness | 3/4 in (19 mm) |

Size Parameters

| | |
|----------------|--------------------------------|
| Minimum | 3 x 5 in (76.2 x 127 mm) |
| Maximum | 50 x 119 in (1270 x 3022.6 mm) |
| Minimum shaker | 8 7/8 x 10 in (225.4 x 254 mm) |

Edgebanding Profile

| | |
|-----------------|------------------------------|
| Top edge | 1.0 mm radius |
| Bottom edge | 1.0 mm radius |
| Edgeband finish | Elegant matte, color matched |

Accessory Products

| | |
|--------------------------|---------------------------------------|
| 1/4 in. thick components | Cut-to-size with raw edges |
| Integrated handle | 1 17/64 and 5/64 in (32 and 2 mm) |
| Floating shelves | 22 to 96 in (558.8 to 2438.4 mm) wide |



Board Specifications

RAUVISIO noir is laminated to a high-quality engineered MDF core that is CARB2, TSCA Title VI certified and NAF (non-added formaldehyde) exempt. The face and the back are identical, and with the consistent substrate, warpage is virtually eliminated.

Edgeband Specifications

All components are edgebanded with REHAU LaserEdge, which provides an extremely heat and moisture resistant seamless joint and creates a matte, solid-surface look.

Cleaning and Care

Clean with a damp microfiber cloth and mild soap if needed. RAUVISIO noir is resistant to most chemicals and solvent-based cleaners, but harsh chemicals should be avoided. Do not use brushes or scouring pads. REHAU is not responsible for any damage done by abrasive cleaning products or procedures.

Protective Coat

A protective peel coat is applied to the top and bottom surfaces. Do not expose peel coat to direct sunlight before removal. Remove promptly after installing cabinet but prior to mounting decorative hardware. To remove peel coat, use rubber fingertips or our peel coat removal tool.

Versatile design options
 RAUVISIO noir provides a completely unique and feel with a monotonic matte surface on both front and back sides. It excels in both vertical and horizontal applications.



Coming
Summer
2021

With **RAUVISIO noir compact™** horizontal and vertical surfaces including countertops, doors, or partitions can be modernized with a stunning monotonic matte look.

RAUVISIO noir compact is a 12 mm thick solid core panel that is made of synthetic thermosetting resins. This balanced panel has identical super-matte surfaces on both sides with a color matched core.

12 mm compact panel

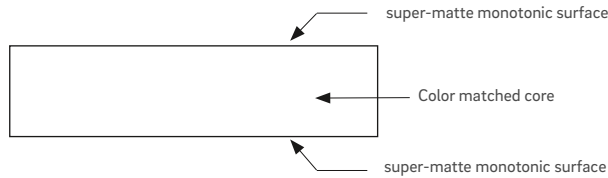

Profile Specifications

| | |
|---------------|--|
| Application | Worktop, countertop, partition |
| Thickness | 15/32 in (12 mm) |
| Sheet size | 51 x 120 in (1300 x 3050 mm) |
| Face material | Super-matte monotonic surface, multiple colors |
| Back material | Super-matte monotonic surface, matching colors |
| Core material | Color matched core |



Sheet Specifications

RAUVISIO noir compact is a 12 mm thick solid core panel that is made of synthetic thermosetting resins. This balanced panel has identical super-matte surfaces on both sides with a color matched core.

Cleaning and Care

Clean with a damp microfiber cloth and mild soap if needed. RAUVISIO noir compact is resistant to most chemicals and solvent-based cleaners, but harsh chemicals should be avoided. Do not use brushes or scouring pads. REHAU is not responsible for any damage done by abrasive cleaning products or procedures.

Protective Coat

A protective coat is applied to the top and bottom surfaces. Do not expose peel coat to direct sunlight before removal. Remove promptly after installing cabinet but prior to mounting decorative hardware. To remove peel coat, use rubber fingertips or our peel coat removal tool.

Color Selection



Casa Blanca 154705



Smoke Stack 154710



Midnight Dash 154713



After Dark 154708

After Dark available now

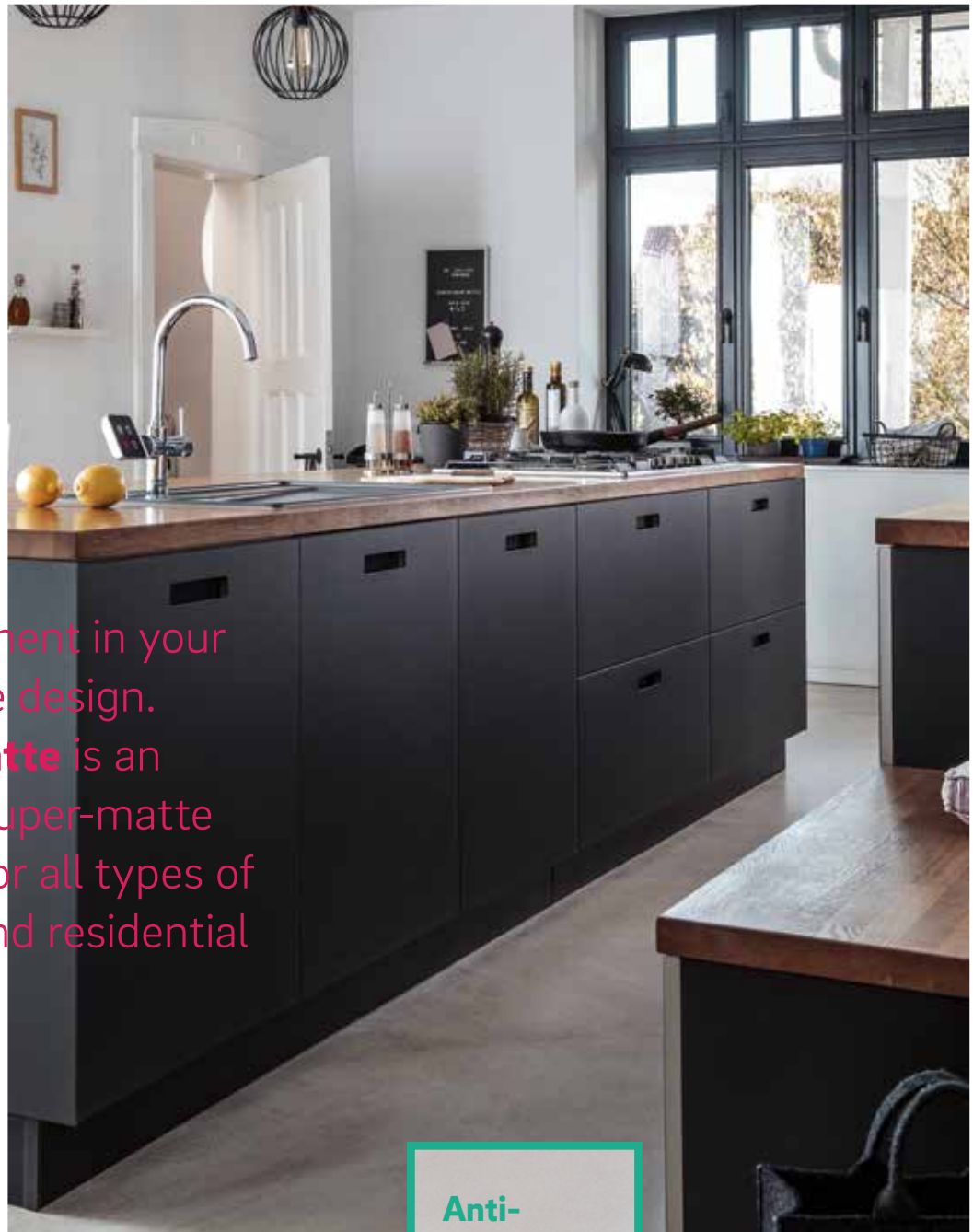

Make a statement in your modern matte design. **RAUVISIO matte** is an outstanding super-matte PET surface for all types of commercial and residential applications.

Anti-fingerprint

Without the extra cost



Create a stunning, sleek look that adds sophistication to your space with RAUVISIO matte surfaces. This trendy design is very practical and suitable for all spaces.

Color Selection



Black 154418



White 154419



Light Grey 154420



Dark Grey 154421



Stone Grey 154422

Slab profile

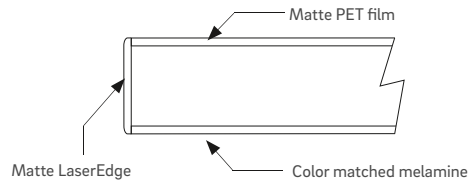

Profile Specifications

| | |
|-----------------|---|
| Appearance | Matte |
| Door style | Slab |
| Design style | Modern, contemporary |
| Construction | Colored PET film laminated to MDF core, REHAU LaserEdge |
| Face material | PET film, multiple colors |
| Back material | Melamine, matching color |
| Edgeband | REHAU LaserEdge, matching color |
| Core | Super-refined MDF |
| Board thickness | 3/4 in (19 mm) |

Size Parameters

| | |
|---------|----------------------------------|
| Minimum | 3 x 5 in (76.2 x 127 mm) |
| Maximum | 47 x 109 in (1193.8 x 2768.6 mm) |

Edgebanding Profile

| | |
|-----------------|------------------------------|
| Top edge | 1.0 mm radius |
| Bottom edge | 1.0 mm radius |
| Edgeband Finish | Elegant matte, color matched |



RAUVISIO matte is a high-quality, soft-touch PET surface with low light reflectivity. REHAU offers the whole product range from board to edgeband to fully-finished cabinet doors.

Board Specifications

RAUVISIO matte is laminated to a high-quality, super-refined, engineered MDF core that is CARB2, TSCA Title VI certified which provides a stable, consistent substrate and virtually eliminates warping.

Edgeband Specifications

All components are edgebanded with REHAU LaserEdge, which provides an extremely heat and moisture resistant seamless joint rivaling solid surfaces.

Cleaning and Care

Clean with a damp microfiber cloth and mild soap if needed. While the surface is scratch resistant, it should never be dry-wiped. Avoid abrasive cleaners, solvent-based cleaners and harsh chemicals. Do not use paper towels, brushes or scouring pads. REHAU is not responsible for any damage done by abrasive cleaning products or procedures.

Protective Coat

A protective peel coat is applied to the top of the matte surface. Do not expose peel coat to direct sunlight before removal. Remove promptly after installing cabinet but prior to mounting decorative hardware. To remove peel coat, use rubber fingertips or our peel coat removal tool.

Get the look and feel of glass without the risk

Experience elegance in design with REHAU polymer crystal and stone surfaces. Our broad range of intensely deep colors, patterns and applications allows creativity without limits.





Enjoy the sleek shine of glass in a lighter-weight, yet durable, polymer with RAUVISIO crystal.

RAUVISIO crystal and crystal slim



10x more break resistant than real glass



A broad range of colors each offering intense color depth



Can be processed with normal woodworking tools



RAUVISIO crystal™ gives all the beauty of beauty of back-painted glass and stone with none of the drawbacks. It can be cut and drilled with normal tools and requires no frame. Our components feature a matching balanced backer and are finished with REHAU LaserEdge.



RAUVISIO crystal acrylic surfaces act as marker (polished) or chalk (natural) board, and are available in on-trend stone patterns as well as a decorative mirror option.





**10x more
break-
resistant**
Than real glass

Color Selection

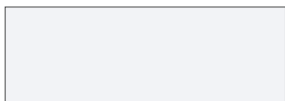

Bianco Polished V2778
Natural 1696L

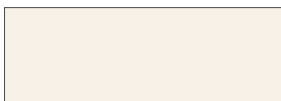

Perla Polished V2892
Natural 1697L



Fumo Polished 1686L
Natural 1702L



Sabbia Polished 1687L
Natural 1703L



Menta Polished 1684L

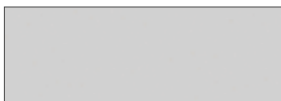

Nebbia Polished 1910L
Natural 1911L



Piano Polished 2015L

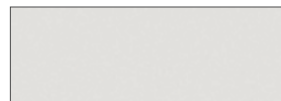

Zucchero Polished 1923L



Legno Sbiancato Polished 1976L



Marmo Bianco Polished 1970L



Marmo Nero Polished 1971L

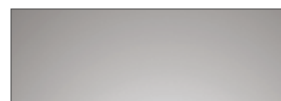

Decorative Mirror Polished 1721L

Polished or natural bevel edge profile

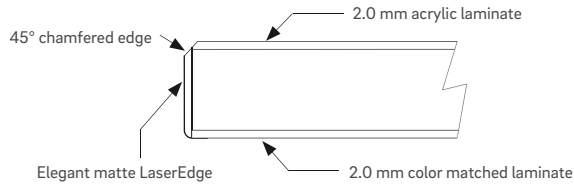

Polished radius edge profile

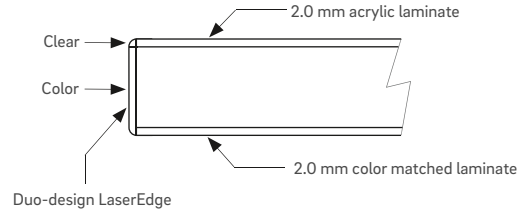

Natural radius edge profile

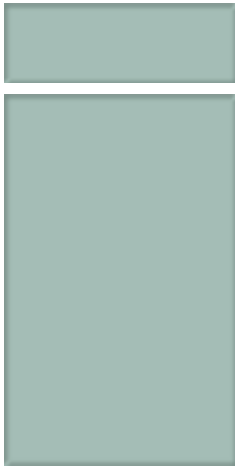
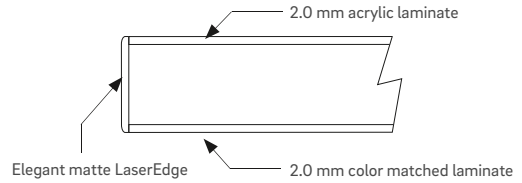

Profile Specifications

| | |
|-----------------|--|
| Appearance | Polished (gloss) or natural (matte) in solid color or stone |
| Door style | Slab |
| Design style | Modern, contemporary |
| Construction | PUR laminated face and back, REHAU LaserEdge |
| Face material | Two-layer polished (gloss) or natural (matte), multiple colors |
| Back material | Balancing sheet, matching color |
| Edgeband | REHAU LaserEdge, matching color |
| Core | Super-refined MDF |
| Board thickness | 3/4 in (19 mm) |

Size Parameters

| | |
|-------------------------------------|--------------------------------|
| Minimum | 3 x 5 in (76.2 x 127 mm) |
| Maximum | 50 x 109 in (1270 x 2768.6 mm) |
| Maximum for RAUVISIO crystal mirror | 47 x 95 in (1194 x 2413 mm) |

Edgebanding Profile

| | |
|-----------------------------|---|
| Top edge | 1.3 mm radius or 45° 3 x 3 mm chamfer |
| Bottom edge | 1.3 mm radius |
| Finish high-gloss, standard | Duo-design or mirror gloss, color matched |
| Finish matte | Elegant matte, color matched |

Accessory Products

| | |
|-------------------|--|
| Backsplash | Thickness 5/32 in (4 mm) Cut-to-size up to 50 x 109 in (127 x 277 cm) |
| Integrated handle | 1 17/64 and 5/64 in (32 and 2 mm) |



The RAUVISIO crystal acrylic surfaces are laminated onto super-refined MDF using specially formulated PUR glue in a clean room environment to ensure an optical grade reflective quality and perfectly balanced panels.

Board Specifications

RAUVISIO crystal is flat-laminated to a high-quality, super-refined, engineered MDF core that is PEFC, CARB2, TSCA Title VI certified which provides a stable, consistent substrate and virtually eliminates warping.

Edgeband Specifications

RAUVISIO crystal polished components are edgebanded with matching mirror gloss REHAU LaserEdge, trimmed at 45°, giving a glossy chamfered edge or using duo-design REHAU LaserEdge with a 2.0 mm clear layer at the top to match the 2.0 mm crystal glass laminate sheet allowing the glass effect to continue all the way to the edge.

RAUVISIO crystal natural components are edgebanded with our matching REHAU LaserEdge elegant matte edgeband trimmed at 45°, giving a glossy chamfered edge just like real frosted glass when cut. You can also choose a traditional radius edge. The bottom edge is a typical radius to give a proper appearance against the cabinet.

Cleaning and Care

Clean with a damp microfiber cloth and with a mild soap if needed. RAUVISIO crystal has a very hard, scratch-resistant finish. Avoid abrasive cleaners, solvent-based cleaners and harsh chemicals. Do not use paper towels, brushes or scouring pads. REHAU is not responsible for any damage done by abrasive cleaning products or procedures.

Protective Coat

A protective peel coat is applied to the top of the surface, as well as to the edge-banded sides. Do not expose peel coat to direct sunlight before removal. Remove promptly after installing cabinet but prior to mounting decorative hardware. To remove peel coat, use rubber fingertips or our peel coat removal tool.



With **RAUVISIO crystal slim™** walls in new builds and renovation projects can be easily updated and modernized with a fresh back-painted glass look. Unlike real glass, this panel can be flexibly installed, measured and cut on site.



50% lighter panels mean flexible design and ease of installation on site.

Unlike real glass, RAUVISIO crystal slim is 50% lighter and can be cut, drilled and routed on the job site.

Beauty with application range

The system design of RAUVISIO crystal slim allows for a wide range of applications, including kitchen or bath backsplash, shower walls, partition walls or fillers. Use perfectly matched with RAUVISIO crystal cabinet doors or as a reflective accent.

Color Selection

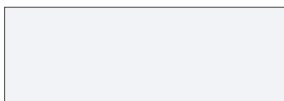

Bianco Polished V2778
Natural 1696L

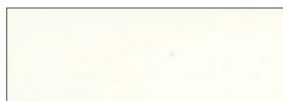

Perla Polished V2892
Natural 1697L

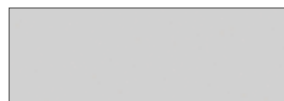

Nebbia Polished 1910L
Natural 1911L



Sabbia Polished 1687L
Natural 1703L



Fumo Polished 1686L
Natural 1702L



Legno Sbiancato Polished 1976L



Marmo Bianco Polished 1970L



Marmo Nero Polished 1971L

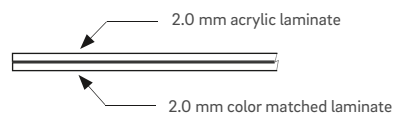

Decorative Mirror Polished 1721L

Slim profile**Profile Specifications**

| | |
|---------------|--|
| Application | Backsplash, wall panel |
| Thickness | 5/32 in (4 mm) |
| Sheet size | 51 x 110 in (1300 x 2800 mm) |
| Face material | Two-layer polished (gloss) or natural (matte), multiple colors |
| Back material | Balancing sheet, matching color |

**Sheet Specifications**

RAUVISIO crystal slim is a 2 mm thick clear acrylic laminate with a colored bottom layer, laminated to a 2 mm thick color-matched backer sheet. The total thickness is 4 mm. Because RAUVISIO crystal slim does not have a wood core, it is 100% waterproof and can be used in a wet environment.

Applications

RAUVISIO crystal slim is a great, modern alternative to use instead of glass in the kitchen and bathroom. It can serve as a backsplash, decorative wall panel or a shower wall cladding. Please note that if using RAUVISIO crystal slim as a backsplash behind a gas cooktop, it must be at least 12 in (304.8 mm) from an open flame. If this is not possible, we suggest installing a flame retardant material directly behind the cooktop.

Cleaning and Care

Clean with a damp microfiber cloth and mild soap if needed. RAUVISIO crystal slim has a very hard, scratch-resistant finish. Avoid abrasive cleaners, solvent-based cleaners and harsh chemicals. Do not use paper towels, brushes or scouring pads. REHAU is not responsible for any damage done by abrasive cleaning products or procedures.

Protective Coat

A protective peel coat is applied to the top of the glass surface. Do not expose peel coat to direct sunlight before removal. Remove promptly after installing RAUVISIO crystal slim. To remove peel coat, use rubber fingertips or our peel coat removal tool.



Bring the outside in with RAUVISIO natural surfaces

Impress with unique characteristics inspired by natural materials for any project application.





RAUVISIO terra



A soft touch finish sets it apart from other products



Impact-resistant HPL exceeds durability of melamine

RAUVISIO wave



Intensely three dimensional texture with paintable color option



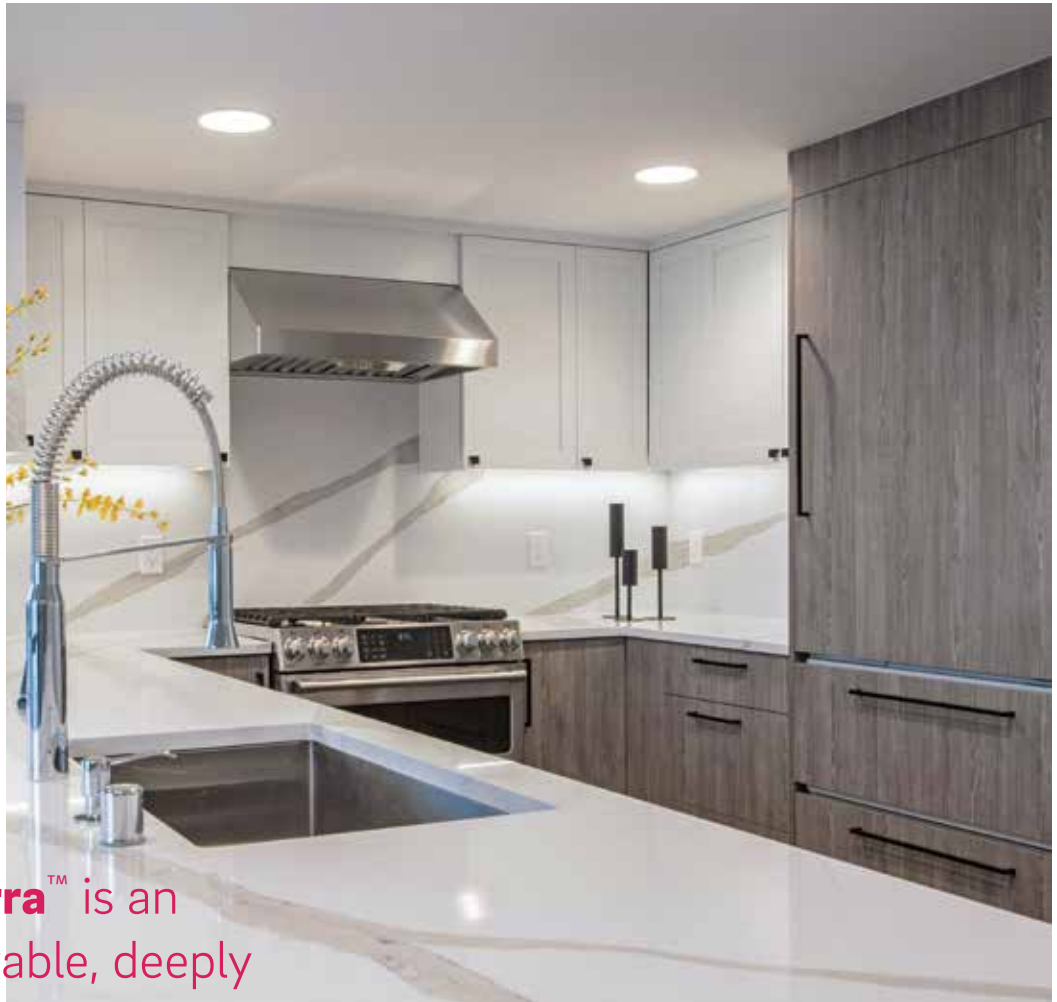

RAUVISIO terra™ is an extremely durable, deeply textured surface made from HPL rather than melamine paper. Our components feature double-sided woodgrain with matching REHAU LaserEdge edgeband.



RAUVISIO terra sheets are laminated to MDF boards. Both top and bottom laminate sheets are identical and perfectly balanced.

The look and feel of custom wood cabinetry can be yours with RAUVISIO terra finished with REHAU LaserEdge™, the latest adhesive-free laser edging technology. The result is a seamless board that rivals solid wood doors.

Color Selection



Whiskey Oak 4511



Mountain Oak 4512



Vineyard Oak 4526



Mission Maple 4520

**Unique
soft touch**
Rugged durability



Lakefront Elm 4539



East Elm 4548



Loft Oak 4517



Dusk Pine 4513



Northern Oak 4574



Craft Elm 4538



Coastal Oak 4543



Harvest Walnut 4604



Riverfront Elm 4528



Saw-cut Sand 4533



West Highland White 0028



Top: slab
Center: 5-piece shaker
Bottom: 3-piece sienna

Slab profile

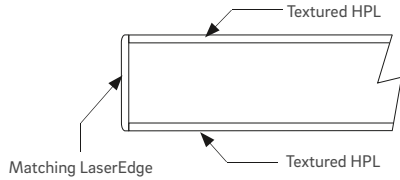

Shaker profile

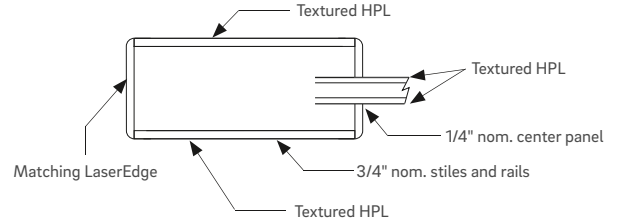

Profile Specifications

| | |
|--------------------------|--|
| Appearance | Natural wood |
| Door style | Slab, shaker and 3-piece |
| Design style | Modern, transitional |
| Construction | PVA laminated face and back, REHAU LaserEdge |
| Shaker stiles and rails | 3 in (76.2 mm), custom widths also possible |
| 3-piece stiles and rails | 3 in (76.2 mm), custom widths also possible |
| Face material | Deep embossed HPL, multiple colors |
| Back material | Deep embossed HPL, matching color |
| Edgeband | REHAU LaserEdge, matching color |
| Core | MDF |
| Grain direction | Choose vertical or horizontal |
| Board thickness | 3/4 in (19 mm) |

Size Parameters

| | |
|-----------------|--------------------------------|
| Minimum | 3 x 5 in (76.2 x 127 mm) |
| Maximum | 50 x 119 in (1270 x 3022.6 mm) |
| Minimum shaker | 8 7/8 x 10 in (225.4 x 254 mm) |
| Minimum 3-piece | 6 x 10 in (152.4 x 254 mm) |

Edgebanding Profile

| | |
|-----------------|-------------------------|
| Top edge | 1.0 mm radius |
| Bottom edge | 1.0 mm radius |
| Edgeband finish | Textured, color matched |

Accessory Products

| | |
|--------------------------|---------------------------------------|
| 1/4 in. thick components | Cut-to-size with raw edges |
| Integrated handle | 1 17/64 and 5/64 in (32 and 2 mm) |
| Floating shelves | 22 to 96 in (558.8 to 2438.4 mm) wide |



**Extremely
durable
surface**



Order with complete confidence

Order custom RAUVISIO terra doors with grain-flow or grain-matching for complete, continuous design. Modern, deeply textured woodgrains complete with REHAU Laser-Edge available to any shop without investment in machinery.

Board Specifications

RAUVISIO terra is laminated to a high-quality, engineered MDF core that is CARB2, TSCA Title VI certified and NAF (non-added formaldehyde) exempt. The face and the back are identical, and with the consistent substrate, warpage is virtually eliminated.

Edgeband Specifications

All components are edgebanded with REHAU LaserEdge, which is extremely heat and moisture resistant and results in a board that looks like a solid piece of wood.

Cleaning and Care

Clean with a damp microfiber cloth and mild soap if needed. RAUVISIO terra is resistant to most chemicals and solvent-based cleaners, but harsh chemicals should be avoided. Do not use brushes or scouring pads. REHAU is not responsible for any damage done by abrasive cleaning products or procedures.

Protective Coat

There is no protective peel coat on RAUVISIO terra products.



Bring movement into your design with **RAUVISIO wave**, a dynamic structured laminate that creates a fascinating light and shadow effect.

Make a statement

RAUVISIO wave makes that statement. The wave-like surface looks like a milled and lacquered panel. Since the surface does not require manual machining, RAUVISIO wave provides considerable time and cost savings.





Decorative,
3D and
paintable

Color Selection

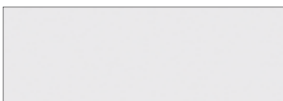

Bianco

1744L



Moro

1745L

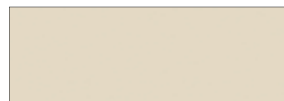

Paintable

1746L

Slab profile

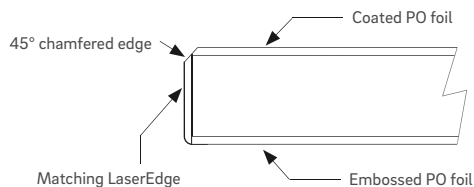

The wave pattern is positioned parallel to the narrow side (1300 mm) – reminiscent of a deep-milled and lacquered MDF board.



Profile Specifications

| | |
|-----------------|--|
| Appearance | Structured |
| Door style | Slab |
| Design style | Modern, contemporary |
| Construction | Coated, scratch-proof polyolefin (PO) foil, WPC base with fleece layers, REHAU LaserEdge |
| Face material | Coated PO foil in black, white and paintable colors |
| Back material | Embossed PO foil, matching color |
| Edgeband | REHAU LaserEdge, matching color |
| Core | MDF |
| Board thickness | 3/4 in (18.4 mm) |

Size Parameters

| | |
|---------|--------------------------------|
| Minimum | 3 x 5 in (76.2 x 127 mm) |
| Maximum | 50 x 109 in (1270 x 2768.6 mm) |

Edgebanding Profile

| | |
|-----------------|--------------------------------|
| Top edge | 45° 3 x 3 mm chamfer |
| Bottom edge | 1.5 mm radius |
| Edgeband finish | REHAU LaserEdge, color matched |



Board Specifications

RAUVISIO wave is laminated to a high-quality, engineered MDF core that is PEFC, CARB2, TSCA Title VI certified which provides a stable, consistent substrate and virtually eliminates warping.

Edgeband Specifications

All components are edgebanded with REHAU LaserEdge, which is extremely heat and moisture resistant and results in a board that is.

Cleaning and Care

Clean with a damp microfiber cloth and mild soap if needed. While the textured surface is scratch resistant, it should never be dry-wiped. Solvent-based cleaners and harsh chemicals should be avoided. Do not use brushes or scouring pads. REHAU is not responsible for any damage done by abrasive cleaning products or procedures

Protective Coat

There is no protective peel coat on RAUVISIO wave products.

RAUVISIO wave comes in a paintable option to fit any design requirement and has flexible processing with only normal woodworking tools required.



Achieve a crisp, modern look with metallic

Design strictly in metallic, or in combination with super-matte or high-gloss surfaces, and offer your clients the industrial design they crave.



RAUVISIO ferro brings the rich history of metallics to add elegant timeless finishes into your spaces.



**RAUVISIO ferro**

Metallic inspired surface provides timeless finishes in everlasting colors

Metallic Line Tambour Doors

Easy installation with customizable counterbalance

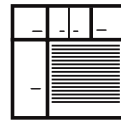

Space-saving design for easy access

Coming
Summer
2021



Create a timeless, elegant modern design with **RAUVISIO ferro** – a metallic PET surface that brings the rich history of metallics to your space. The clear PET film is topped with a metallic inspired print and finished with a UV-cured hard coat and laminated on a MDF core.



Stainless steel finish surfaces perfectly accentuate a neutral color palette. Incorporate brushed stainless steel with contrasting high-gloss surface for an unexpected and uniquely creative finish.

Color Selection



Aegean Anchor

2263L



Metro Motion

2264L



Gilded Arrow

2265L



Empire Skyline

2266L

Slab profile

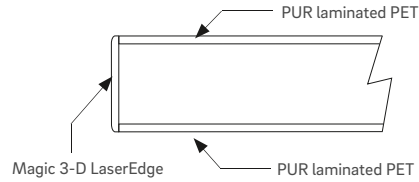

Profile Specifications

| | |
|-----------------|--|
| Appearance | Metal |
| Door style | Slab |
| Design style | Modern, contemporary |
| Construction | PUR laminated PET face and back, REHAU LaserEdge |
| Face material | UV-cured PET, multiple colors |
| Back material | UV-cured PET, matching color |
| Edgeband | REHAU LaserEdge, matching color |
| Core | Super-refined MDF |
| Board thickness | 23/32 in (18.3 mm) |

Edgeband Specifications

| | |
|-----------------|------------------------------------|
| Top edge | 1.0 mm radius |
| Bottom edge | 1.0 mm radius |
| Edgeband finish | Magic 3-D LaserEdge, color matched |

Size Parameters

| | |
|---------|----------------------------------|
| Minimum | 3 x 5 in (76.2 x 127 mm) |
| Maximum | 47 x 109 in (1193.8 x 2768.6 mm) |

Accessory Products

| | |
|-------------------|-----------------------------------|
| Integrated handle | 1 17/64 and 5/64 in (32 and 2 mm) |
|-------------------|-----------------------------------|

Top: Metro motion

Bottom: Gilded Arrow

**Board Specifications**

RAUVISIO ferro uses a state of the art metallic inspired PET laminate to provide a durable metallic surface that is double sided giving the look of a solid metal door. The super-refined, engineered MDF core provides a stable, consistent substrate, virtually eliminating warping.

Edgeband Specifications

All components are edgebanded with a solid 1.0 mm thick 3-D, color matched edgebanding, which provides a permanent joint that is extremely water resistant. The resulting board rivals the look of a real metal door without the weight.

Cleaning and Care

Clean with a damp microfiber cloth and mild soap if needed. Avoid abrasive cleaners, solvent-based cleaners and harsh chemicals. Do not use paper towels, brushes or scouring pads. REHAU is not responsible for any damage done by abrasive cleaning products or procedures.

Protective Coat

A protective peel coat is applied to the top and bottom surfaces. Do not expose peel coat to direct sunlight before removal. Remove promptly after installing cabinet but prior to mounting decorative hardware. To remove peel coat, use rubber fingertips or our peel coat removal tool.

The look of metallic without the drawbacks

The solid 1.0 mm thick metallic PET surface is laminated on an super-refined MDF core.

REHAU **Metallic-Line™** tambour doors give full access to cabinets, operate smoothly and quietly, and require minimal space with no doors that open out into the living area.



REHAU tambour doors come as custom cut-to-size kits built to your specifications, ready-to-install with no extra cutting or fabrication. They are scratch resistant and do not stick or swell with humidity.





**Built
exactly to
your specs**
Cut-to-size kits

Metallic-Line combines the high-quality look of solid aluminum or stainless steel with the functionality of a polymer tambour door.

Color Selection



Brushed Stainless Steel Finish



Natural Aluminum Finish



**Customize a
tambour system
to fit your exact
specifications**

na.rehau.com/tambour

20 mm profile

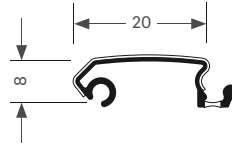

25 mm profile

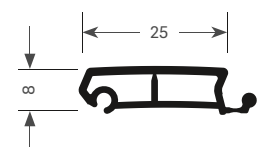

Profile Specifications

| | |
|--------------|---|
| Appearance | Stainless steel or aluminum |
| Door style | Face-mounted tambour door |
| Design style | Modern, contemporary |
| Construction | Anodized aluminum materials (aluminum or stainless steel finish) |

Size Parameters

| | |
|-----------------------|-----------------------|
| Minimum inside height | 18 in (457.2 mm) |
| Maximum inside height | 80 in (2032 mm) |
| Minimum inside width | 18 in (457.2 mm) |
| Maximum inside width | 47.75 in (1212.85 mm) |
| Minimum inside depth | 12 in (304.8 mm) |

Cabinet Specifications

| | |
|------------------------|------------------------------------|
| Cabinet style | Frameless cabinet |
| Cabinet walls | 3-sided (on countertop) or 4-sided |
| Cabinet wall thickness | 3/4 in (19.5 mm) |



But how does it feel?

Combine the quiet running properties and smoothness of polymer tambour systems with the high-quality look and feel of solid aluminum systems. It commands your attention with subtle surfaces and consistent color stability, without sacrificing the popular "cool touch" of solid aluminum or stainless steel surfaces.

Tambour Door Specifications

REHAU Metallic-Line tambour doors are custom, cut-to-size to your specifications and come in aluminum or stainless steel finishes. The tambour slats combine metal and polymer materials to create a soft-hinge design for quiet and smooth operation. The frame and other aesthetic components are solid metal. Tambour door kits feature a counterbalance system to balance the weight of the door and keep it from slamming shut. Door kits come complete and ready-to-install with detailed instructions.

Cabinet Specifications

Metallic-Line must be installed in a frameless cabinet with either four or three sides (on a countertop). The walls should be 3/4 in (19 mm) thick, which provides a 1/8 in (3 mm) reveal around the tambour door. The door will add 3/4 in (19 mm) thickness to the face of the cabinet, just like a standard cabinet door. All dimensions related to the tambour must be given as inside cabinet dimensions (H x W x D).

Cleaning and Care

Clean with a damp microfiber cloth and mild soap if needed. Avoid abrasive cleaners, solvent-based cleaners and harsh chemicals. Do not use paper towels, brushes or scouring pads. REHAU is not responsible for any damage done by abrasive cleaning products or procedures.

Protective Coat

A protective peel coat is applied to the metal surfaces of the tambour components. Do not expose peel coat to direct sunlight before removal. Remove promptly after cabinet door installation. To remove peel coat, use rubber fingertips or our peel coat removal tool.

The new and improved **Vetro-Line™ glass tambour door** system brings glass back into the kitchen with a smooth, refined look. With a hint of transparency, the contents inside the cabinet can be seen, but not completely revealed.

**Tambour doors with flair**

Vetro-Line features slats made of real tempered glass allowing for strength and durability. The sleek surface, along with the door system, creates a modern, industrial look that is well suited for a range of kitchen styles and functions.



**Real
tempered
glass**

Durable strength

Color Selection



White



Smoke

Easy-to-install kit. Tambour door systems offer it all.

Vetro-Line kits feature a fully counterbalanced system to balance the weight of the door at any height and keep it from slamming shut. Door kits come complete and ready-to-install with detailed instructions.

Tambour door ready-to-install custom kit

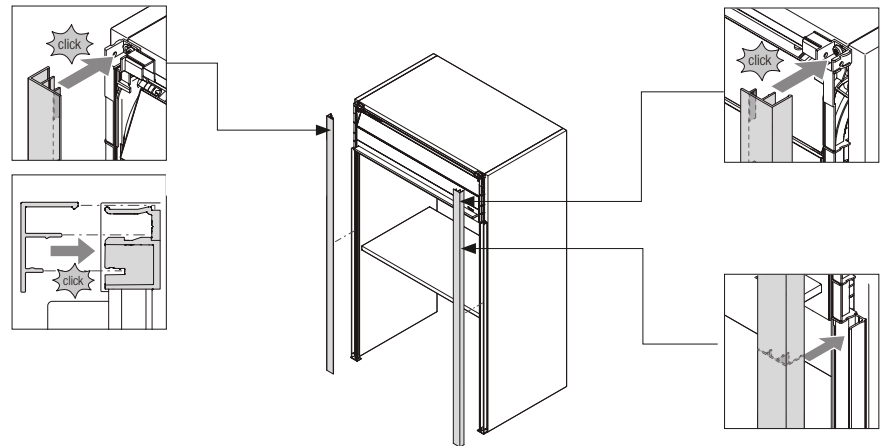

Profile Specifications

| | |
|----------------------------|--|
| Application | Vertical cabinet |
| Appearance | Tempered glass |
| Door style | Face-mounted glass tambour |
| Cabinet outside dimensions | 23 5/8 x 59 adjustable x 3/4 in (600 x 1500 adjustable x 19 mm) |
| Minimum installation depth | 11 3/4 in (296 mm) |
| Slat width | 2 in (50 mm) |
| Mechanism | C-box cassette system, spiral |
| Track system | Anodized stainless steel finish |

Cabinet Specifications

| | |
|------------------------|----------------|
| Cabinet style | Frameless |
| Cabinet walls | 3- or 4-sided |
| Cabinet wall thickness | 3/4 in (19 mm) |



Vetro-Line Specifications

REHAU Vetro-Line glass tambour door systems consist of tempered glass doors with a stainless steel frame. Vetro-Line kits feature a fully counterbalanced system to balance the weight of the door at any height and keep it from slamming shut. Door kits come complete and ready-to-install with detailed instructions.

Cabinet Specifications

REHAU Vetro-Line must be installed in a frameless cabinet with either four or three sides (on a countertop). The walls should be 3/4 in (19 mm) thick, which provides a 1/8 in (3.2 mm) reveal around the glass tambour door. The door will add 3/4 in (19 mm) thickness to the face of the cabinet, just like a standard cabinet door. The Vetro-Line glass tambour door system is designed to fit a 23 5/8 in (600 mm) wide cabinet (outside width), and is offered in heights up to 59 in (1500 mm).

Cleaning and Care

Clean with a damp microfiber cloth and mild soap if needed. Avoid abrasive cleaners, solvent-based cleaners and harsh chemicals. Do not use paper towels, brushes or scouring pads. REHAU is not responsible for any damage done by abrasive cleaning products or procedures.

Protective Coat

There is no protective peel coat on REHAU Vetro-Line glass tambour door systems.

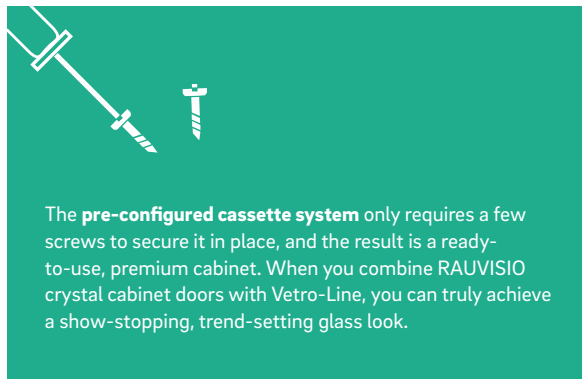

The **pre-configured cassette system** only requires a few screws to secure it in place, and the result is a ready-to-use, premium cabinet. When you combine RAUVISIO crystal cabinet doors with Vetro-Line, you can truly achieve a show-stopping, trend-setting glass look.

REHAU integrated handles personally suit each door or drawer front. With accentuated modern lines and unique streamlined styles, our handles are the perfect final touch to creative cabinet designs.



**Choose
visible or
almost
invisible**

Handle Specifications

| | |
|------------|--|
| Appearance | Recessed profile (2 mm) or J channel (32 mm) |
| Material | Anodized aluminum, multiple colors |
| End Caps | Color matched |

Size Parameters

| | |
|----------------|--------------------|
| Minimum length | 12 in (304.8 mm) |
| Maximum length | 109 in (2768.6 mm) |

Hidden Recessed 2 mm

The 2 mm REHAU integrated handle is almost invisible. It combines exceptionally well with a flat profile and is also designed for upper cabinet doors.

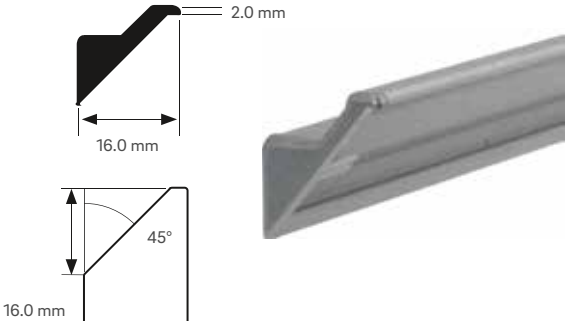

J Channel 32 mm

The 32 mm REHAU integrated handle features a visible channel.

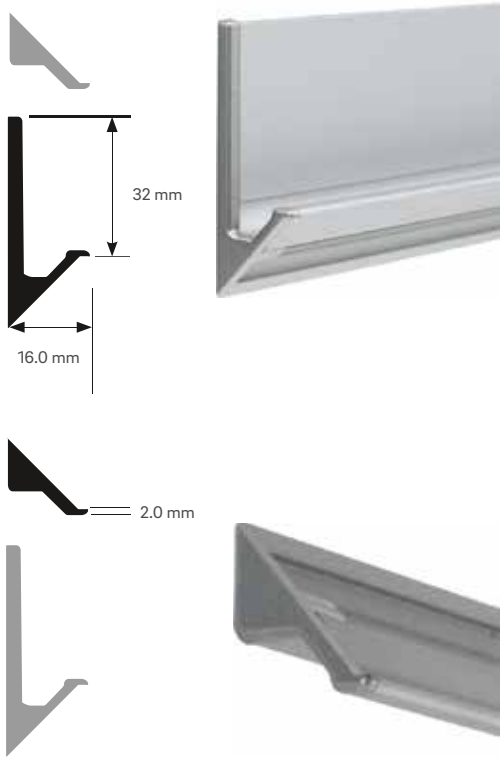

Color Selection



Matte Silver

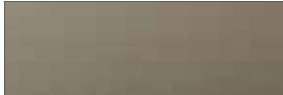

Matte Champagne



Matte Anthracite



Matte Black

REHAU floating shelves

are an elegant way to expand storage for everything from dishes and small appliances to decorative objects, while complementing the clean, no-hardware design of modern cabinets.





**Patented
bracket
design**

Floating shelf kit

REHAU provides a complete floating shelf kit that includes all brackets and hardware needed to install on a typical residential interior wall (2 x 4 in. wall studs 16 in. O.C. behind drywall).

Each floating shelf kit will include:

- Floating shelf
- Brackets
- Mounting/location block
- Hardware
- T25 bit for rugged structural screws
- Installation instructions

Required for installation (not included)

- Cordless drill/driver
- Level
- Pencil
- Wall stud finder

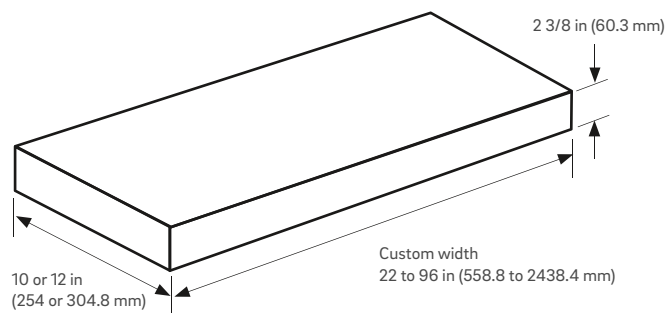

Specifications

| | |
|-----------|---|
| Depth | 10 or 12 in (254 or 304.8 mm) |
| Thickness | 2 3/8 in (60.3 mm) |
| Width | 22 to 96 in (558.8 to 2438.4 mm) |
| Material | RAUVISIO brilliant, RAUVISIO terra, RAUVISIO noir |

Applications

REHAU floating shelves are designed to use in any room for a sleek minimalistic storage option. They must be installed on a typical residential interior wall with studs.

Cleaning and Care

Clean with a damp microfiber cloth and mild soap if needed. Avoid abrasive cleaners, solvent-based cleaners and harsh chemicals. Do not use paper towels, brushes or scouring pads. REHAU is not responsible for any damage done by abrasive cleaning products or procedures.

Protective Coat

Depending on the surface, a protective peel coat may be applied to the top and bottom of the floating shelf. Do not expose peel coat to direct sunlight before removal. Remove promptly after installing the floating shelf. To remove peel coat, use rubber fingertips or our peel coat removal tool.

Getting Started

Order custom cabinet doors online through REHAU's online order portal. To create a new account, simply go to www.na.rehau.com/cabinetdoors

Once you sign up, our customer service team will complete your profile and apply your personal discount.

If you place an order before this has been done, your order will be placed on hold until your profile is completed. You may be required to purchase through a distributor. In this case, you can place the order online, and your distributor will contact you to complete your purchase.

Engineering progress
Enhancing lives

Your order ships in just days
High demand colors

Forge a refined foundation
RAUVISIO noir™ monotonic matte is an irresistibly lush surface that leaves nothing to chance by obscuring fingerprints and scratches. Linger with the visual and tactile sensation of entirely seamless matte.

REHAU

Username:

Password:

Remember me

Esceci.rehau.com?l

Log In **Create Account**

Engineering progress
Enhancing lives

Forge a refined foundation

RAUVISIO evo™ economic matte is an irresistibly lush surface that leaves nothing to chance by obscuring fingerprints and scratches. Larger with the visual and tactile sensation of entirely seamless mattes.

REHAU

Categories: [Finish](#), [Cabinet Doors](#), [Facades and Fronts](#), [Shelves](#)

product search...

Slab Doors Slab Doors with Integrated Handles 5-piece Shaker Doors

3-Piece Doors Floating Shelves

RAUVISIO crystal

RAUVISIO crystal RAUVISIO crystal edgeland Edgeland Trimming

Sabbie 1687L Sabbie 3170E radius (standard)

radius crystal laminate VDF core crystal backer

expanding

| Qty | Width | Height | Cabinet ID (no commas) | Product |
|--------------------------------|-------------------------------------|-------------------------------------|--------------------------------|--------------|
| <input type="text" value="2"/> | <input type="text" value="23 7/8"/> | <input type="text" value="6 7/8"/> | <input type="text" value="1"/> | Drawer Front |
| <input type="text" value="2"/> | <input type="text" value="23 7/8"/> | <input type="text" value="24 1/4"/> | <input type="text" value="1"/> | Door |

[Add Row](#)

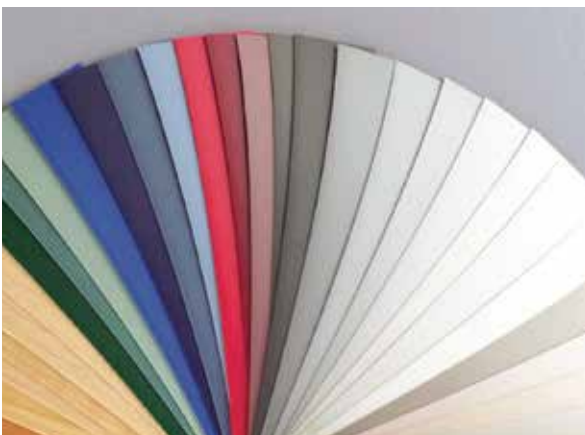

The REHAU Cabinet Door Order Portal

Our easy online tool takes you through each step of the process. You can request a sample or a quote or place an order with just the click of your mouse.

Ordering Information

Order Details

- Orders placed in inches or millimeters (upon request)
- Order exact size down to nearest 1/16 in (1.5 mm)
- Order will be in width x height measurements
- All pricing is per square foot, FOB our fabrication center
- Shipping charges are added at time of order (when using order portal)

Grain Direction

Grain matching is available for RAUVISIO radiant and RAUVISIO terra. Components with vertical grain direction can be cabinet matched, while components with horizontal grain direction can be grain-flow matched.

Lead Times

Lead times may vary per product. Typical orders ship within 7 business days but may take up to 15 business days to depart. The order portal will inform you if the lead time will be longer than 7 business days. The day after you receive your acknowledgment is business day one provided a PO has been sent. Please contact Customer Service at (888) 734-2810 for the most up-to-date lead times.

Order Confirmation

All orders are confirmed within 24 hours via email. Contact Customer Service at (888) 734-2810 if you do not receive an order confirmation.

All orders enter production the day following the order confirmation to allow for changes. Orders will be placed on hold until PO is received. Any order discrepancy must be reported to Customer Service within 24 hours of order receipt. REHAU is not liable for unreported order errors or discrepancies.

Order Changes and Cancellations

Changes or cancellations must be received in writing within 24 hours. Any changes made after the 24-hour cutoff may result in a 50-100% change fee unless the order is not yet in production.

Note: If you are purchasing REHAU cabinet doors through a distributor, please contact your distributor regarding any changes to your order.

Shipping and Delivery

Orders will ship LTL or UPS based on the component size and order size. Customers have a choice between REHAU carrier and customer carrier. If REHAU carrier is chosen, the shipping costs will be added based upon size and weight at the time of order. If customer carrier is chosen, there will not be any shipping charges applied, however there will be a packaging fee (\$25-\$150) applied after the order is placed.

Note: If you do not have a loading dock or you are delivering to a residence, please select "UPS Ground" or "Freight with lift gate" when placing the order.

Receiving Your Order

We strive to ship your orders accurately, completely and on time. Please inspect the contents of your shipment before signing your delivery receipt. If you are unable to inspect the contents upon receipt, and there is no visible damage to the packaging or skid, please note "Subject to Inspection for Internal Damage" on the bill of lading.

Damage, Defects or Missing Product

Any damage or missing items due to damaged packaging must be documented on the bill of lading at time of delivery, otherwise REHAU will not be held responsible. Photograph any exterior packaging damage before inspecting contents.

All damage and defects, concealed or not, and missing product must be reported within 48 hours of receipt to Customer Service at (888) 734-2810. When calling, please have the following information available: Order or Article No., Tracking or BOL No. and Date Received.

Remake Orders

When damages, defects or errors are found with your order, within 48 hours of delivery, contact Customer Service at (888) 734-2810 or request a remake through the order portal.

To request a remake, click on your original order and select the button labeled "Request A Remake." Next, choose the components to remake and explain the reasoning why. Then, click "Save Changes." Your request will then be processed and expedited. Please make sure to submit photos clearly showing the reason for the remake. Remake requests without photos may not be processed.

Note: If you are purchasing REHAU cabinet doors through a distributor, please contact your distributor with the sizes and quantities to be remade.

Service and Care

Warranty

Components manufactured by REHAU are warranted against defects occurring in the material or manufacturing process under normal use for 10 years from the date of original purchase. Complete warranty information can be found on our website at www.na.rehau.com/warranties

Warranty covers repair or replacement of product only. REHAU's liability will not exceed the invoiced amount of the covered product. Products manufactured outside our normal specifications are not covered by our warranty.

Our manufacturing tolerance is +/- 1/32 in. or 1 mm. Warp specification is 1.2 mm per linear foot. We recommend storing all components in a temperature controlled environment upon delivery. We do not offer a warranty on 5-piece (shaker) style doors larger than 65 in.

Heat and Moisture Resistance

Our products are engineered to meet strict European AMK kitchen tests for heat, humidity and water vapor intrusion. We've tested to 158°F (70°C), which exceeds KCMA standards requiring 24 hours at 120°F (49°C), and 70% humidity without showing discoloration, blistering or other material failure.

We are not responsible for material damage due to excessive heat and moisture beyond these specifications.

Cleaning and Care

Remove protective film immediately following installation. We recommend using rubber fingertips or our peel coat removal tool. We do not recommend using a razor blade or any sharp objects to remove the peel coat.

Once protective film has been removed, components can be cleaned with mild soap and water and a damp cotton cloth. Do not use brushes, scouring pads or any abrasive materials on surfaces. Avoid any solvent-based cleaners or harsh chemicals.

Custom Cut-to-Size Options

Doors and Drawer Fronts

Components are approximately 3/4 in. thick and are edgebanded on all four sides.

End Panels

We offer door and drawer panel matching base, tall and wall-applied end panels edgebanded on all four sides. End panels are rectangular and are designed to capture the toe kick.

Filler Panels

Filler panels come as approximately 3/4 in. thick components with your choice of either the two short sides or two long sides edgebanded. Note that the minimum width must be at least 3 in. for the long sides to be edgebanded, and the minimum width must be at least 3 in. for the short sides to be edgebanded. It is therefore recommended to order filler panels in 3 in. widths and then rip them down to size during installation.

Raw Boards and Edgeband

We have laminated boards in approximately 3/4 in. thickness (raw edge) available, along with matching edgeband coils for all of our products. These can be ordered through REHAU Marketplace or you can contact Customer Service at (888) 734-2810 for more information.

1/4 in. Panels

We offer select surfaces in approximately 1/4 in. thickness cut-to-size with raw edges.

Surface Options at a Glance

| Surface | Board Size | Slab Doors | 5-piece Doors | 3-piece Doors | 1/4 in Board Cut-to-Size | 3/4 in Pressed Board | Laminate Sheets | Floating Shelves | Integrated Handles |
|-------------------------|--|------------|---------------|---------------|--------------------------|----------------------|-----------------|------------------|--------------------|
| RAUVISIO brilliant | 1300 x 2800 x 19 mm 51 x 110 x 3/4 in | . | . | . | . | . | . | . | . |
| RAUVISIO crystal | 1300 x 2800 x 19 mm 51 x 110 x 3/4 in | . | | | | . | | | . |
| RAUVISIO crystal mirror | 1220 x 2440 x 19 mm 48 x 96 x 3/4 in | . | | | | . | | | . |
| RAUVISIO noir | 1300 x 3050 x 19 mm 51 x 120 x 3/4 in | . | . | | . | . | . | . | . |
| RAUVISIO matte | 1220 x 2800 x 19 mm 48 x 110 x 3/4 in | . | | | . | . | | | |
| RAUVISIO terra | 1300 x 3050 x 21 mm 51 x 120 x 13/16 in | . | . | . | . | . | . | . | . |
| RAUVISIO wave | 1250 x 2800 x 18.5 mm 49 x 110 x 3/4 in | . | | | | . | | | |
| RAUVISIO ferro | 1220 x 2800 x 19mm 48 x 110 x 3/4 in | . | | | | | | | . |



**Engineering progress
Enhancing lives**

Customer Service Contacts

Hours Monday to Friday, 8 am to 7:30 pm EST

www.na.rehau.com/cabinetdoors

United States

Phone (888) 734-2810 Fax (616) 285-7622

Canada

Phone (888) 905-0345 Fax (514) 905-0490



For updates to publication, visit na.rehau.com/resourcecenter

The information contained herein is believed to be reliable, but no representations, guarantees or warranties of any kind are made as to its accuracy, suitability for particular applications or the results to be obtained therefrom. Before using, the user will determine suitability of the information for user's intended use and shall assume all risk and liability in connection therewith.